

TOTO

Head Office

TOTO Europe GmbH
Zollhof 2, 40221 Düsseldorf Germany
Tel: +49 (0)700 8686 0700

TOTO

WASHLET

Instruction Manual



WASHLET

TCF6532G/GE/SW
TCF6530G/GE/SW
TCF6532C3GV1

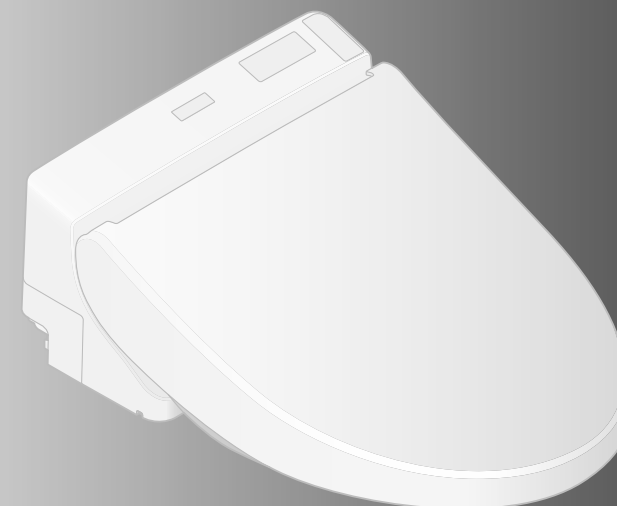

You are advised to record the following information to allow quick service.

Date of purchase :	Name of shop :
Date : year month day	
	Tel :

- Thank you for your recent purchase of the product.
Please read the enclosed information to ensure the safe use of your product.
- Be sure to read this Instruction Manual before using your product and keep it in a safe place for future reference.

2015.7.24
D08955
Printed in China.

What functions are available on your model?

Functions		Product name (Model) Part No.	WASHLET		Ref. Page	
			TCF6532	TCF6530		
Cleansing	Rear cleansing				16	
	Rear soft cleansing		●			
	Front cleansing					
Basic Functions	Changing the washing method	Wand position adjustment			16, 17	
		Water pressure adjustment				
		Oscillating cleansing		●		
		Pulsating cleansing				
		Personal setting lock				
Drying	Warm air drying		●		16	
Changing the temperature	Temperature adjustment		●		22, 23	
Sanitary Functions	Removing odors	Deodorizer		●	20, 21	
	Bowl pre-cleaning	Pre-mist		●		
Convenient Functions	Heating the toilet seat	Heated seat		●	—	
	Saving energy	Energy Saver		●	24, 25	
Maintenance	Removable toilet lid			●	28	
	Wand cleaning			●	29	

Product name,
Part No.

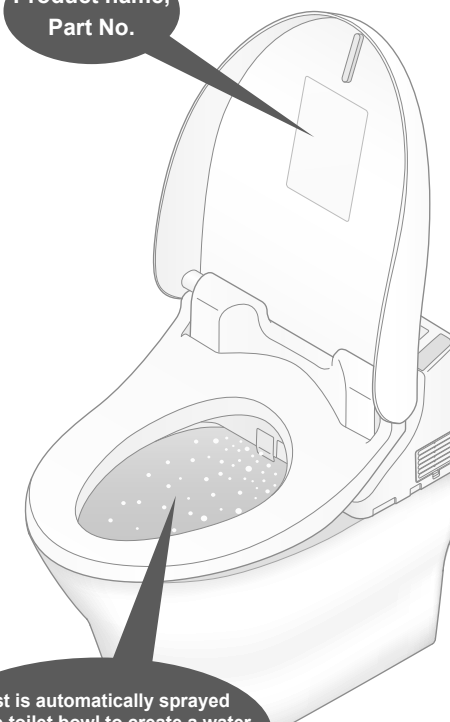

A mist is automatically sprayed in the toilet bowl to create a water cushion, which prevents dirt from adhering to the surface.

The self-cleaning functions operate automatically. (See pages 20 for details.)

As you sit	
A mist is sprayed inside the toilet bowl to make it more difficult for dirt to adhere.	Pre-mist
Removing odors inside the toilet bowl.	Deodorizer



Table of Contents

	Introduction
Safety Precautions	4
Operational Precautions.....	11
Parts Names	12
Preparation.....	14
Operation	
Basic Operations	16
Automatic Functions	20
DEODORIZER, PRE-MIST	
Temperature Adjustment.....	22
Energy Saver Feature	24
Maintenance	
Power Plug	26
Main unit.....	27
Gap between the Main Unit and the Toilet Lid	28
Deodorizing Filter	29
Wand	29
Wand cleaning	
Spray Nozzle	30
Water Filter Drain Valve, Water Drain Plug	31
Reference	
Changing Settings	32
What to Do?.....	38
● If you cannot operate with the remote control	38
● Freeze Damage Prevention... ..	38
● Long Periods of Disuse	40
Troubleshooting	41
Specifications	45
Warranty	46
Important User Guidance Information.....	46



Safety Precautions

These precautions are important for safe usage. Be sure to follow them and use the product correctly.

Symbols and Meanings

	WARNING May result in death or serious injury.
	CAUTION May result in injury or property damage.

The following symbols are used to indicate important safety instructions for the use of the product.

Symbol	Meaning
	This symbol indicates a prohibited use of the product.
	This symbol is used to indicate a required step in the use of this product.

- This product is classified as Class 1 Equipment and must be grounded.
- Install this equipment where the electrical outlet is accessible.
- This appliance is not intended for use by persons (including children) with reduced physical, sensory or mental capabilities, or lack of experience and knowledge, unless they have been given supervision or instruction concerning use of the appliance by a person responsible for their safety. Children should be supervised to ensure that they do not play with the appliance.
- Use the new hose set included with this equipment. Do not reuse an old hose set.

WARNING

	Do not touch the power plug or connection of electrical box with wet hands. • Doing so may cause electrical shock.
	Do not get any water or cleaning solution on the main unit or power plug or electrical box. • Doing so may cause fire, electrical shock, heat or short circuit. • Doing so may cause the product to crack resulting in injury or water damage.
	Never disassemble, repair or alter. • Doing so may cause fire, electrical shock, heat or short circuit.
	Do not install the product on moving vehicles such as wheeled vehicles or boats. • Doing so may cause fire, electric shock, short circuit or malfunction. • The toilet seat, toilet lid, main unit or other parts may come loose and fall off, resulting in injury.

WARNING

Do not use the Washlet if a malfunction occurs.

- Always unplug the plug from the outlet. Always switch the breaker on the distribution board to OFF. (Electrical box type, Concealed power connection type)
- Close the water shutoff valve to stop water supply.
Possible malfunctions:
 - Water is leaking from a pipe or the main unit.
 - The product is cracked or broken.
 - The product makes a strange noise or emits a strange odor.
 - The product emits smoke.
 - The product is abnormally hot.
 - The toilet seat cushion is out of place.
- Continued use after malfunction could cause a fire, electric shock, heat, short circuit, injury or water damage.

Only use tap water or potable well water (underground water).

Do not use seawater.

- Doing so may cause irritation to the skin and malfunction.

Do not touch the power plug or electrical box during thunderstorms.

- Doing so may cause electrical shock.



Do not allow the water supply hose to touch the power plug or outlet or electrical box.

- Doing so may cause condensation resulting in a fire, electrical shock, heat or a short.

Do not do anything that may damage the power cord, power plug.

Do not strike, yank, twist, excessively bend, damage, alter, or heat the electrical cords. Also, do not place anything heavy on, bind or pinch the electrical cords.

- Using a damaged electrical cord may result in a fire, electrical shock, heat or short.

Do not use a loose or faulty electrical outlet.

(Except electrical box type, Concealed power connection type)

- Doing so may cause fire or short circuit.

Do not use any outlet or wiring equipment beyond its specified rating.

- Plugging too many plugs into the same outlet, for example using outlet splitters, can cause fire due to heat.

Do not use any power supply other than the one specified.

AC 220V - 240V, 50Hz

- Doing so may cause fire or excessive heat.

Safety Precautions (Continued)

WARNING

To reduce the danger of burns, death from electric shock, fire or other human injury:

- Never operate this product if it has a damaged cord or plug, if it is not working properly, if it has been dropped or damaged, or if it has been dropped in water. Return the product to TOTO Europe GmbH for examination and repair.
- Never block the air openings of the product or place it on a soft surface, such as a bed or a couch, where the air openings could be blocked. Keep the air openings free of lint, hair or a similar material.
- Never use it while sleepy or drowsy.
- Never drop or insert anything into any opening or hose.
- Do not use it outdoors where aerosol (spray) products are being used or where oxygen is being administered.

Do not stick a finger or anything else into the warm air outlet.

Do not place anything on the warm air outlet or drape clothes over it.

- Doing so may cause burns, electrical shock or malfunction.

Keep cigarettes and other open flames away from the product.

- Failure to do so may cause fire.

Beware of irritation or burn

- Improper use of the toilet seat may cause irritation or burn.
- When sitting for a long time on the toilet seat, switch the toilet seat temperature adjustment to "OFF". When any of the following persons use a heated seat or warm air drying, someone should switch the toilet seat temperature adjustment to "OFF" and switch the drying air temperature to "Low".
- Young children, the aged and other users unable to set the temperature appropriately themselves
 - The ill, physically disabled and others who do not have freedom of movement.
 - Those using any medicines that cause drowsiness (sleeping or cold medicine), those who have been drinking heavily, anyone severely fatigued and anyone else liable to fall asleep.

To reduce the danger of burns, death from electric shock, fire or other human injury:

- Close supervision is necessary when this product is used by or near children or invalids.
- Use this product only for its intended use as described in this manual. Do not use accessories not recommended by the manufacturer.
- Keep the cord away from heated surfaces.
- Connect this product to a properly grounded outlet only.
- The tank should only be filled with water.

WARNING

This is an electrical product. Do not install it anywhere water is likely to get on the product or anywhere with humidity high enough that water is likely to form on the surface of this product. When using the product in a bathroom, install a fan or ventilation port and ensure good air flow through the bathroom.

- Failure to do so may cause fire or electrical shock.

Always connect the Washlet to the cold water supply.

- Connecting to hot water supply may result in burns and equipment damage.

Check that an appropriate ground is installed.

- If the ground is not installed, if there is a breakdown or electrical current leak, the lack of a ground could cause electrical shock.
- For the ground, use copper wire with a ground resistance of 100 Ω max. and a diameter of 1.6 mm min.
- * If there is no ground installed, ask the contractor who did the installation to install the ground.

Make sure that a properly grounded (3 prong) outlet has been installed.

- Failure to install a grounded outlet could cause electrical shock in the event of a malfunction or short circuit.

Check that the outlet for electrical power is as follows.

- Failure to do so may cause fire or electrical shock.
- a. Apply a current to the outlet (or device) through a differential residual current device whose release current does not exceed 30 mA.
 - b. Install the outlet (or device) and its wiring plug at least 0.60 m away from the outside of the shower tub or bathtub.
- * Check that the wiring in a. and b. above is complete. If the wiring has not been completed, ask the contractor who did the installation to do it.

Insert the power plug securely into the outlet.

Check that the power cord is connected.

(Electrical box type, Concealed power connection type)

- Failure to do so may cause fire, heat or short circuit.
- * When installing this product, observe the local laws and regulations regarding installation.

To unplug, hold the plug, not the cord.

(Except electrical box type, Concealed power connection type)

Do not unplug by pulling the cord.

- Pulling on the cord may cause damage and result in fire or heat.

If the electric cord is damaged, avoid danger by having the manufacturer's repair department or equivalent specialist replace it.

Safety Precautions (Continued)

WARNING



Always disconnect the power plug from the outlet before cleaning, maintenance or inspection.

Always switch the breaker on the distribution board to OFF.

(Electrical box type, Concealed power connection type)

- Failure to do so may cause electrical shock or malfunction.

Periodically remove dust and dirt from the power plug and make sure it is securely plugged into the wall outlet.

(Except electrical box type, Concealed power connection type)

- Failure to do so may cause fire, heat or short circuit.
Pull the plug out from the outlet and wipe clean with a dry cloth.

CAUTION

Do not use the product if the main unit is unstable.

- Doing so may cause the main unit to come loose and fall, resulting in injury.

* If there is backlash in the main unit, consult the installer, seller or the contact listed on the back cover of this manual.

If the product is damaged, do not touch the damaged section.

- Doing so may cause electrical shock or injury.

Replace it immediately.

Do not apply strong force, mechanical shock, step on or stand on the toilet seat, toilet lid or main unit. Also do not place any heavy object on the toilet seat, toilet lid or main unit.

- Doing so may cause cracking or cause the main unit to come loose and fall, resulting in injury.
- Doing so may damage the product and cause injury or water damage.

Do not lift up this product by the toilet seat or lid.

Do not raise the toilet seat or lid while objects are resting on top of the toilet.

- Doing so may cause the main unit to come loose and fall, resulting in injury.

To reduce the danger of death from electric shock:

- Do not use while bathing.
- Do not place or store the product where it could fall or be pulled into a tub or sink.
- Do not put in or drop into water or other liquid.
- Do not try to recover the product if it has fallen into water. Unplug it immediately.
Switch the breaker on the distribution board to OFF. (Electrical box type, Concealed power connection type)

When cleaning or maintaining the plastic parts (main unit etc.) or the water supply hose, use a kitchen cleaner diluted with water. Do not use any of the following.

Toilet cleaner, household cleaner, benzene, paint thinner, powdered cleanser or nylon scrubbing pads.

- These items may damage or crack the plastic and cause injury or malfunction.
- These items could damage the water supply hose and cause a water leak.

To prevent a sudden water leak, do not remove the water filter drain valve when the shutoff valve is open.

- Doing so will cause water to spurt out.

(Refer to Page 31 for instructions on cleaning the water filter drain valve.)

Do not fold or crush the water supply hose; do not damage by cutting with a sharp object.

- Doing so may cause water leaks.

Safety Precautions (Continued)

CAUTION

If a water leak should occur, always close the shutoff valve.

When the ambient temperature is likely to drop to 0°C or lower, prevent damage to the pipes and hoses due to freezing.

- Frozen water pipes could cause the main unit and the pipes to break, resulting in a water leak.
- Regulate the room temperature to prevent the pipes and hoses from freezing during cold months.
- Drain the water.

When not using the Washlet over an extended period of time, drain the water out of the main unit and the water supply hose after closing the water shutoff valve, and pull the electrical plug from the outlet.

Switch the breaker on the distribution board to OFF. (Electrical box type, Concealed power connection type)

- When using the product again, allow the product to refill with water first. Otherwise, the water in the tank might become contaminated and cause skin inflammation or other problems. (Refer to Page 39 for instructions on replenishing the water.)
- Leaving the power on may cause fire or heat.

When installing the water filter drain valve, make sure that it is securely tightened in its proper position.

- Failure to securely tighten it may cause a water leak.

Operational Precautions

For prevention of malfunctions

- Do not block the remote control transmitter or receiver.

< About the seat switch >

- When you sit on the toilet seat, the seat switch turns ON, enabling you to use various features. (A click sound is heard when the seat switch is ACTIVATED.)

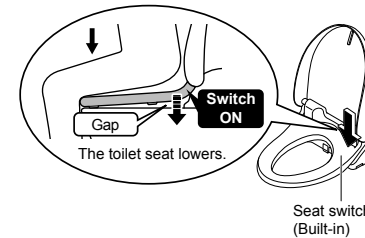

- Sit back on the toilet seat.
 - The seat switch will not turn on unless you sit on the seat properly.



Note

- When a child uses the Washlet, the seat switch may not be ACTIVATED by their light body weight.
- Since the toilet seat is designed to move up and down, a clearance is provided between the toilet seat cushion and the toilet bowl.

For prevention of damage

- Wipe plastic areas such as the main unit and remote control with a soft cloth tightly wrung out with water.
- Do not lean against the toilet lid.



Problem Prevention

- Disconnect the power plug if there is a risk of lightning. Switch the breaker on the distribution board to OFF. (Electrical box type, Concealed power connection type)
- A toilet seat cover or a toilet lid cover cannot be used. (The seat switch may not function properly.)



- Do not urinate on the main unit, toilet seat or wand. (Doing so may cause pink or brown stains or a malfunction.)
- Do not apply strong forces to the control panel of the remote control.
- When using a toilet cleaner to clean the toilet, wash it off within 3 minutes and leave the toilet seat and toilet lid open. Wipe off any cleaner that remains on the toilet bowl. (If vapor from a toilet bowl cleaner enters the main unit, it may cause a malfunction.)
- Do not use the product with the toilet lid removed.
- Do not expose to direct sunlight. (Doing so may cause changes in color, irregular heated seat temperature, remote control malfunction or Washlet malfunction due to the change in temperature.)
- Use radios, etc. away from the Washlet. (The Washlet could cause interference with the radio signal.)
- If you use a booster seat for infants or a soft highchair, remove it after use. (Keeping it installed may prevent some of the functions from being used.)
- Do not apply force to the remote control. (May cause malfunction.) To prevent the remote control from being dropped, set it in the hanger when you are not using it. Be careful not to expose it to water.
- Do not place anything on the toilet seat and lid, and do not press them with hands. Failure to do so may turn on the seat switch, causing the floor to get wet if buttons on the remote control are touched and warm water comes out from the wand. (The seat switch may turn on if force is applied to the toilet seat or lid.)

About rear cleansing, rear soft cleansing and front cleansing

- These functions wash away waste and dirt from a localized area of your body.
- Do not cleanse too much or for too long. Doing so may wash away normal bacteria, upsetting the balance of bacteria inside your body.
- People who are receiving medical treatment or therapy in this localized area should consult their doctor before use.

Parts Names

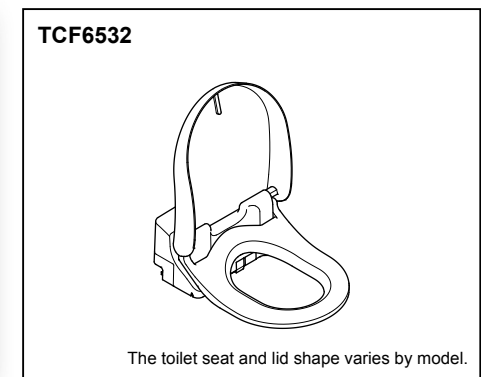
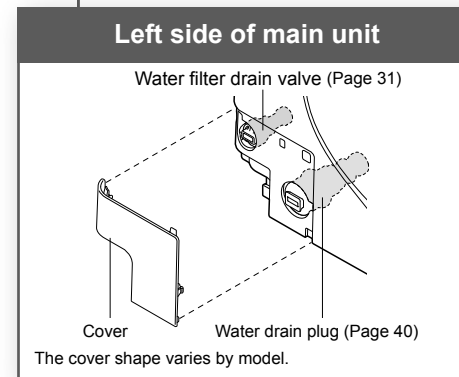
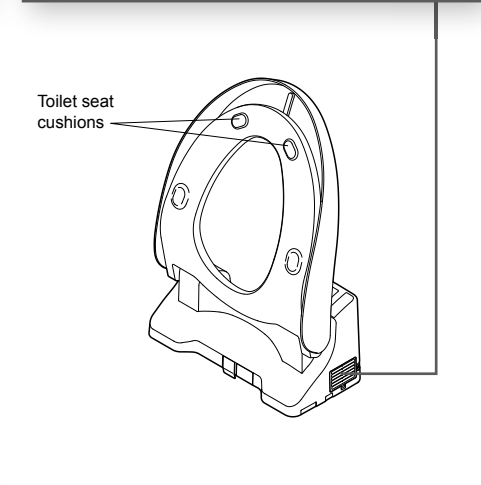
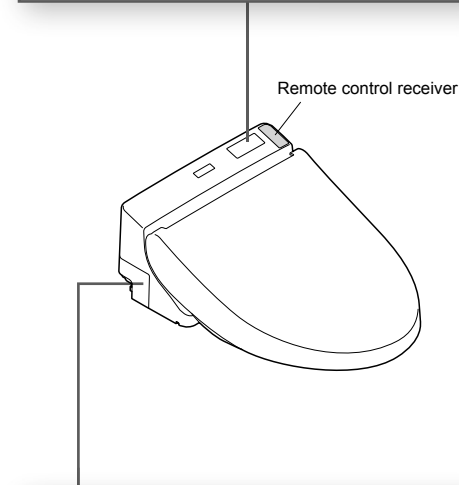
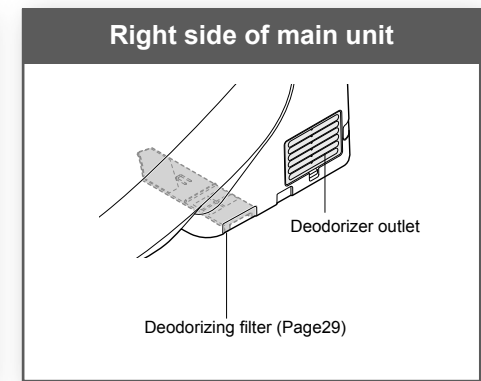
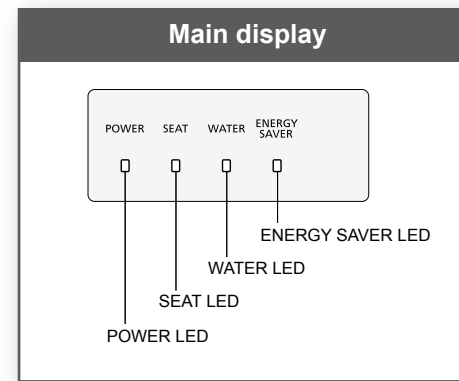
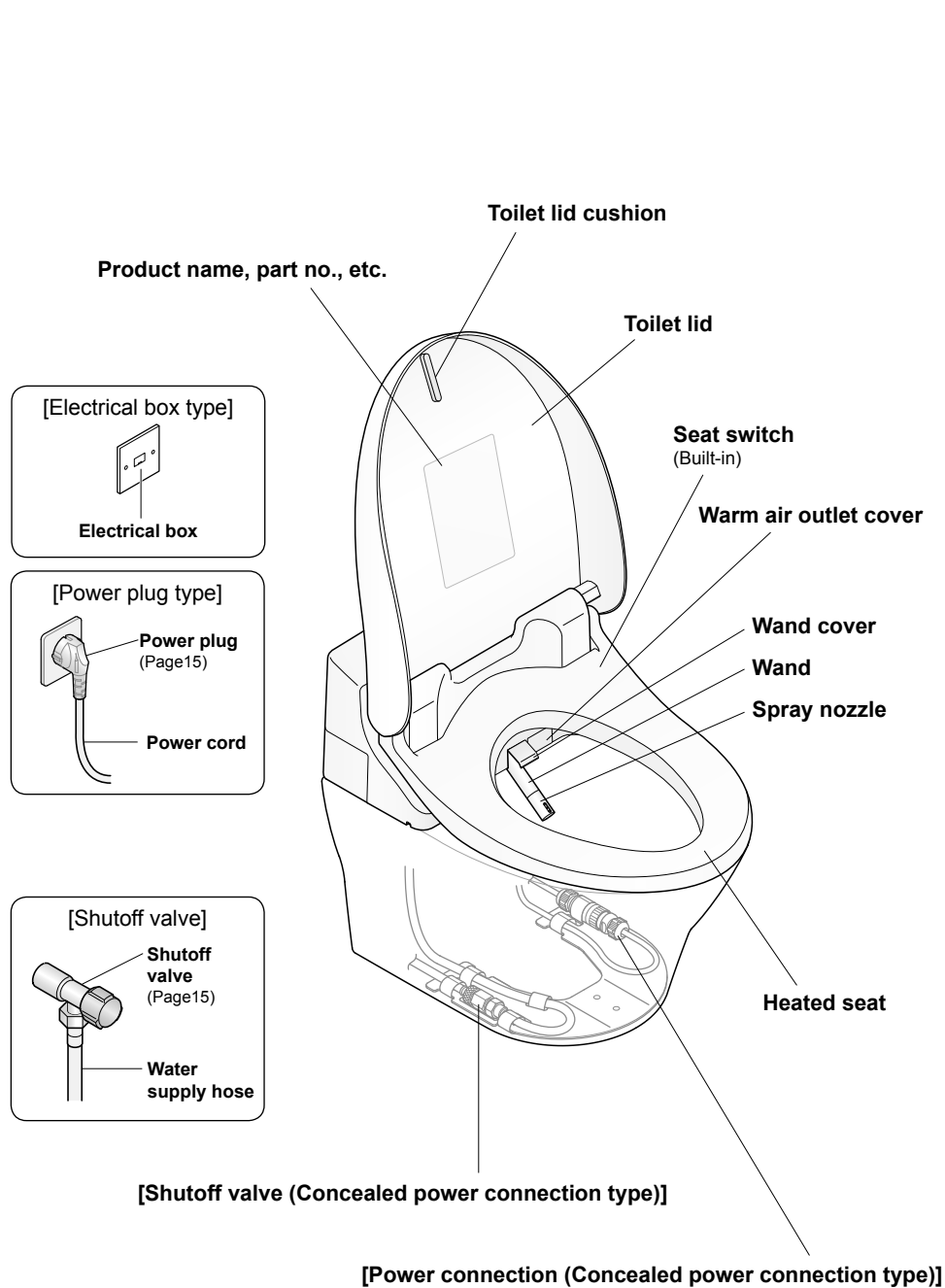

Descriptions in this manual are based on the illustrations of TCF6530.

Preparation

Using the Product for the First Time

1. Insert the battery

- 1 Remove the remote control from the hanger.

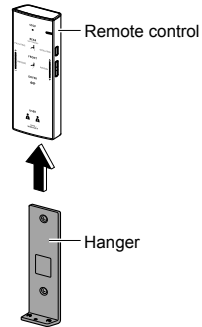

- 2 Open the battery cover and insert two AA batteries.

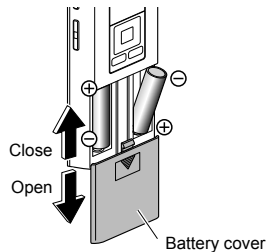

- When batteries are properly inserted, temperature levels appear on the display of the remote control (back side).
- The display goes out when no button on the remote control is pressed for 5 minutes or more.

- 3 Mount the remote control in the hanger.

■ About the batteries

- Use dry cell, alkaline batteries. Follow the instructions below to prevent the batteries from rupturing or leaking fluid.
- When replacing the batteries, use new batteries of the same brand.
- If you will not be using the remote control for a long time, remove the batteries.
- Do not use rechargeable batteries.

If the remote control is secured (for anti theft)

- 1 Remove the screw from the remote control fixture.

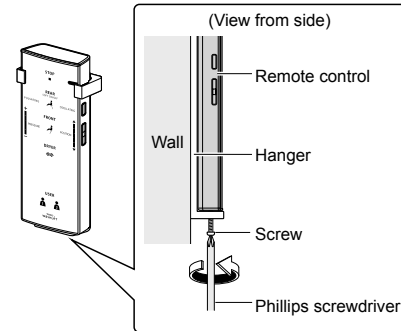

- 2 Remove the remote control from the hanger.

- To secure the remote control again
Tighten the screw.
(Overtightening may cause damage to parts such as the hanger)

2. Turn on the power

- 1 Insert the power plug.
Switch the breaker on the distribution board to ON.
(Electrical box type, Concealed power connection type)
- The wand extends and then retracts.

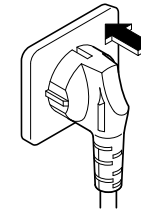

- 2 Check that the POWER LED on the main display is lit up.

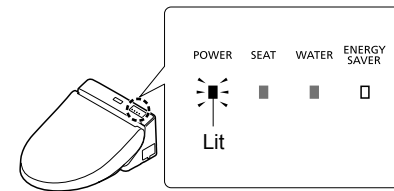

3. Open the shutoff valve

- 1 Fully open the shutoff valve.

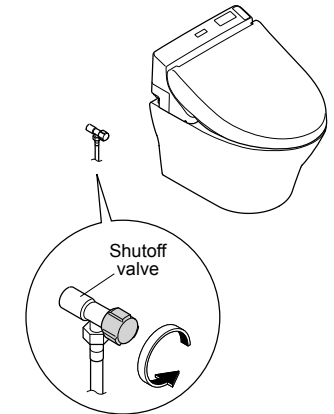

[For shutoff valve (Concealed power connection type)]

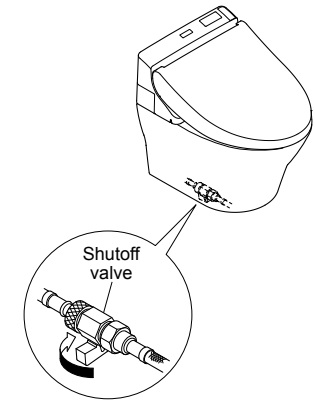

Note

- If the tank is empty it will take some minutes until water is discharged from the nozzle.

Basic Operations

Press a button on the remote control; a beep sounds when the main unit receives the signal.

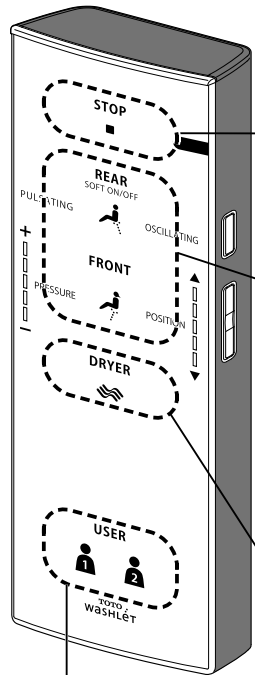

Stopping

[STOP]

Stops the operation.

Cleansing

[REAR]

Cleanses your rear.



[SOFT]

Washes your rear with mild water pressure.

*The mode changes between [SOFT] (Flickering) and [REAR] (Lit) each time the button is pressed.



[FRONT]

Serves as a bidet for ladies.

Drying



[DRYER]

Dries your rear.

Personal Setting

[USER1] / [USER2]

You can store your preferred wand position, water pressure and water temperature a setting.

- To store a setting

While cleansing is in progress, set your preferred wand position, water pressure, and warm water temperature, and then press and hold [USER 1] or [USER 2] for 2 seconds or longer.

- To use

Press [USER 1] or [USER 2], and then press the button for the cleansing you want to use.

*The wand position and water pressure lamps will light up for about 10 seconds in their set positions, and the water temperature display switches.

- Functions that operate when a button is pressed during "REAR", "SOFT" or "FRONT" cleansing.

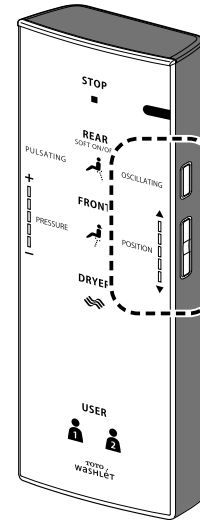

[OSCILLATING]

- The wand moves back and forth to wash your rear thoroughly.
- The setting changes between "ON" and "OFF" each time the button is pressed.

[POSITION]

- The wand position can be adjusted to the front or rear.
("▲": Moves to the front, "▼": Moves to the rear)

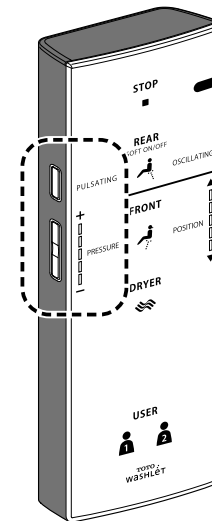

[PULSATING]

- Washes with the water pressure pulsating between soft and strong.
- The setting changes between "ON" and "OFF" each time the button is pressed.

[PRESSURE]

- The water pressure strength can be adjusted for cleansing functions such as REAR. ("•": Softer, "+": Stronger)

Note

- Sitting back on the toilet seat makes it easier to adjust the wand position and to reduce splashing.

For your information

- Water may sometimes come out from around the wand while water is warmed up or when it expands in the warm water tank.
- As warm water tank is used as hot water system, the temperature of warm water may become lower if it is continuously consumed.

Basic Operations

About the Menu Screen

This section is an overview of the settings that can be configured with the remote control.

- See the corresponding pages for the detailed descriptions.

Remote control back side

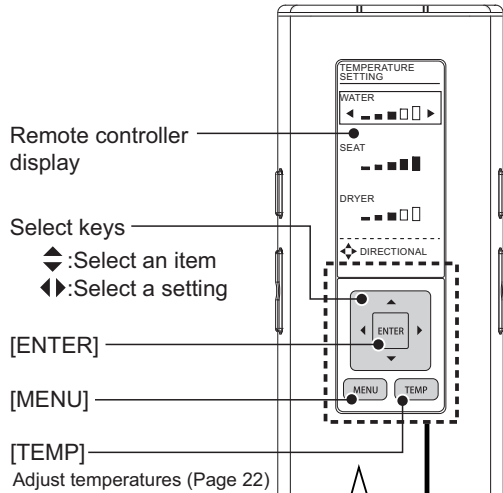

Press [MENU] to display the menu screen.

1 Press **[MENU]**.

- The display screen changes.

2 Set the item from the display screen.

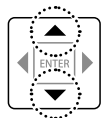

When you move the **Up/Down** buttons (Up/Down), the frame of the item moves.

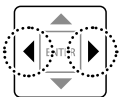

When you move the **Left/Right** buttons (Right/Left), you can select "Setting".

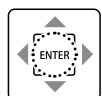

When you press the **ENTER** button, the item is entered.

SETTING LOCK

You can lock the settings so that you do not mistakenly operate the rear buttons while using the remote control.

How to Set (Page 36)

Display screen during setting lock



You can set as desired

If you want to return to the previous item, press the **[MENU]** button.

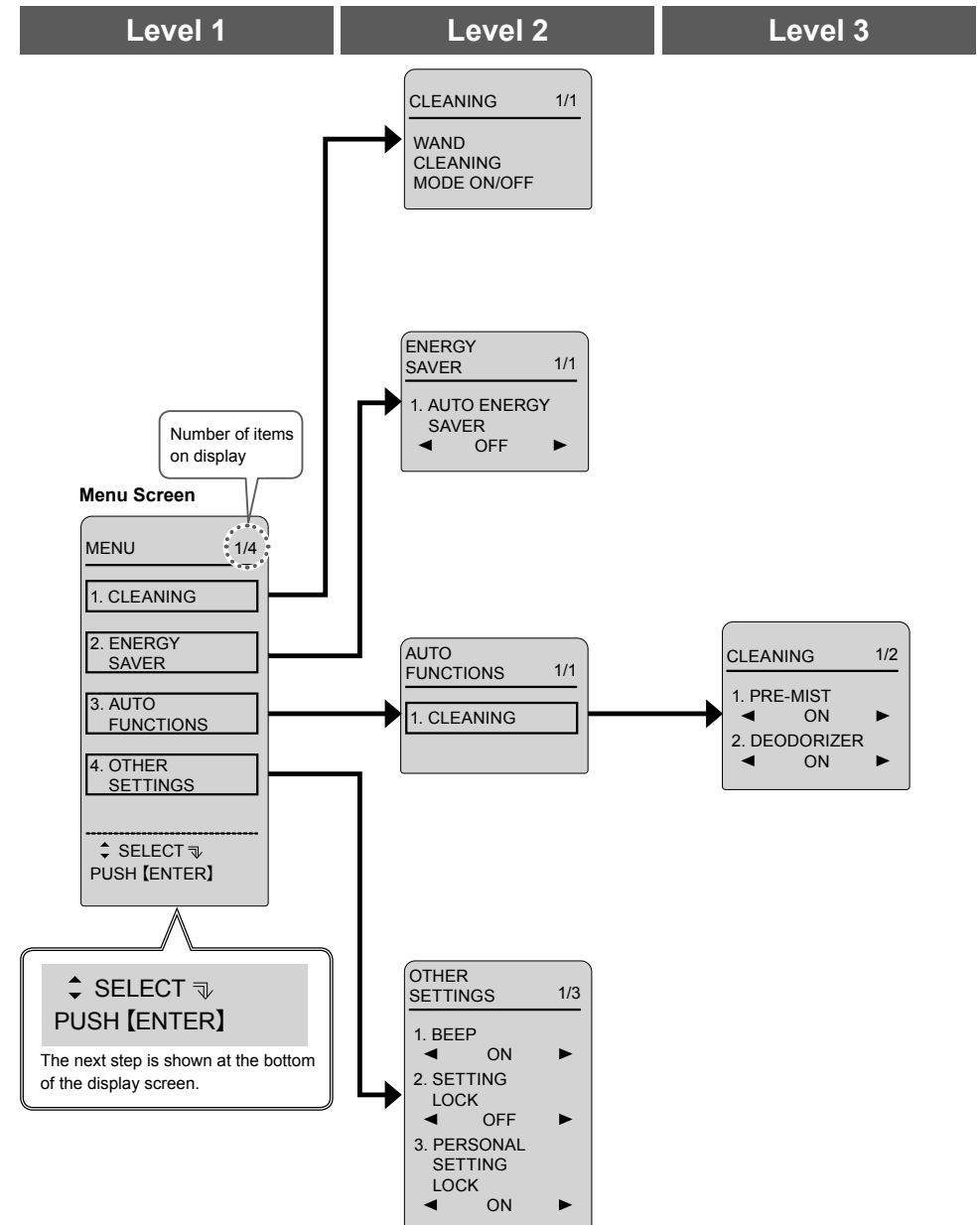

Automatic Functions Cleaning Features



■ Note

■ Changing settings

Removing odors inside the toilet bowl
DEODORIZER



Starts the deodorizer

Deodorizer stops
→It stops after about 2 minutes

- DEODORIZER ON/OFF (Page 34)

A mist is sprayed inside the toilet bowl to make it more difficult for dirt to adhere
PRE-MIST



A mist is sprayed inside the toilet bowl

- The pre-mist will not spray for about 90 seconds after you stand up from the toilet seat.

- PRE-MIST ON/OFF (Page 34)



* Water comes out from around the wand.



Temperature Adjustment

Warm Water / Toilet Seat / Drying

You can adjust the temperature levels or turn the settings to "OFF".

1  Press [TEMP].

2  Use  to select the item you want to set.

3  Use  to select the <Settings complete> temperature level.

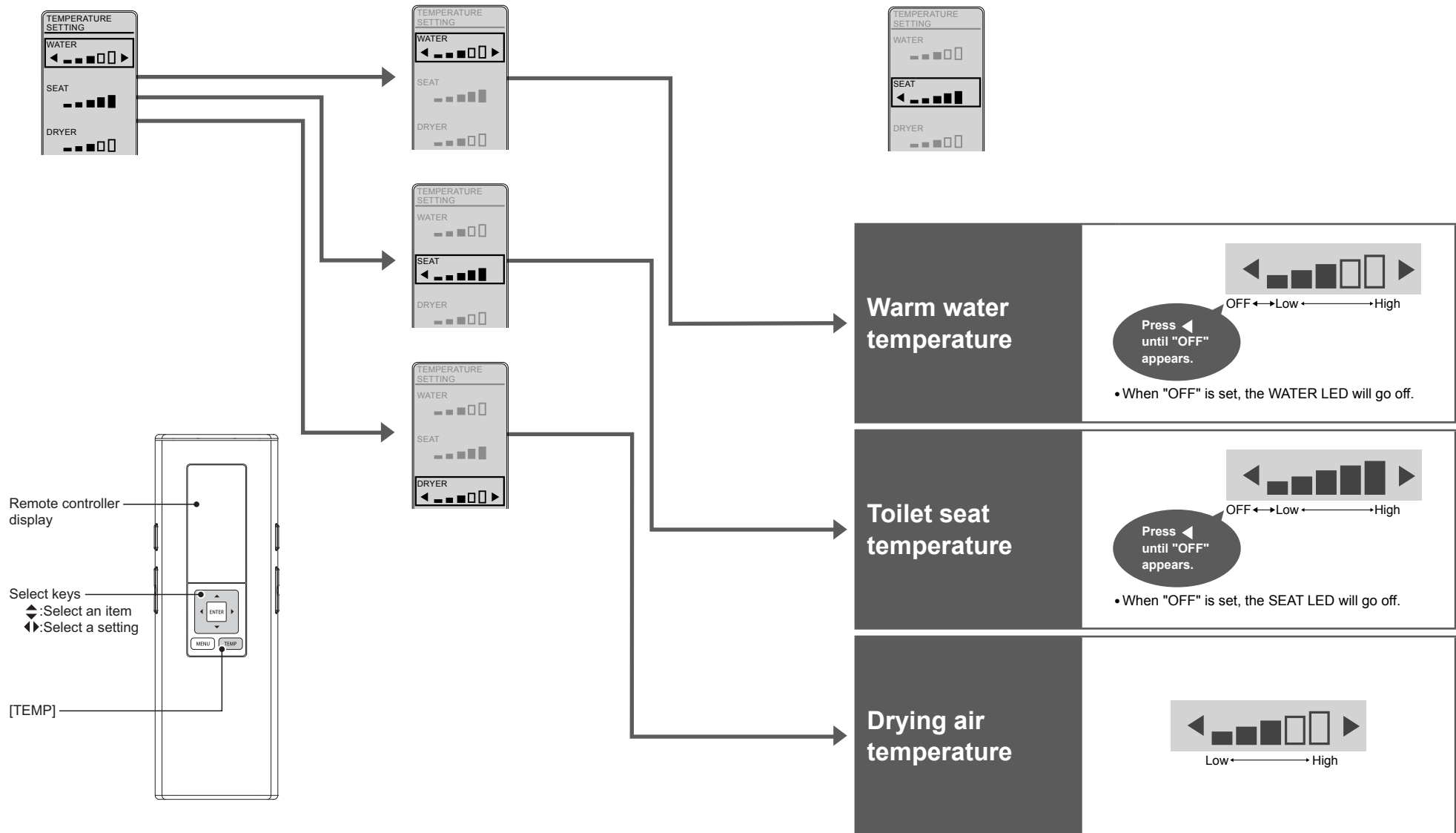

Energy Saver Feature

You can save energy by turning the toilet seat heater to a low temperature (or turning the heater "OFF") during periods when the toilet will be used infrequently.

When the energy saver feature is "OFF", the temperature is kept at the same level.

- It takes about 10 days for the product to determine the periods when it is used relatively less frequently.

Situation	When energy saver is set	When energy saver is in operation		AM PM						
	Main Display	Toilet seat heater	Warm water heater	0	6	8	5	9	0	
You want the Washlet to save energy automatically The Washlet detects time periods with infrequent use and lowers the toilet seat temperature automatically. Furthermore, it automatically turns off the toilet seat and warm water heater during time periods when the toilet is never used.		Time period with infrequent use 	Low 	Set temperature ¹ 	Example) Time period with infrequent use (from 9:00PM to 6:00AM): Low Time period the toilet is never used (8:00AM to 5:00PM): OFF					
	When energy saver is not set 	Time period the toilet is never used 	OFF 	OFF 	OFF ^{*3}					

Note

- Even if the ENERGY SAVER is being activated (with the toilet seat heater set to "Low" or "OFF," or with the warm water heater set to "OFF"), the toilet seat will be temporarily heated when you sit on it. (To reach the setting temperature, the toilet seat takes about 15 minutes and the warm water about 10 minutes, respectively.)

*1 The temperature set on Page 22.

*2 The time period when the toilet seat heater is set to a "low temperature" by the energy saver. The warm water heater is "Set temperature".

*3 The time period when the toilet seat heater and warm water heater are "OFF".

How to set

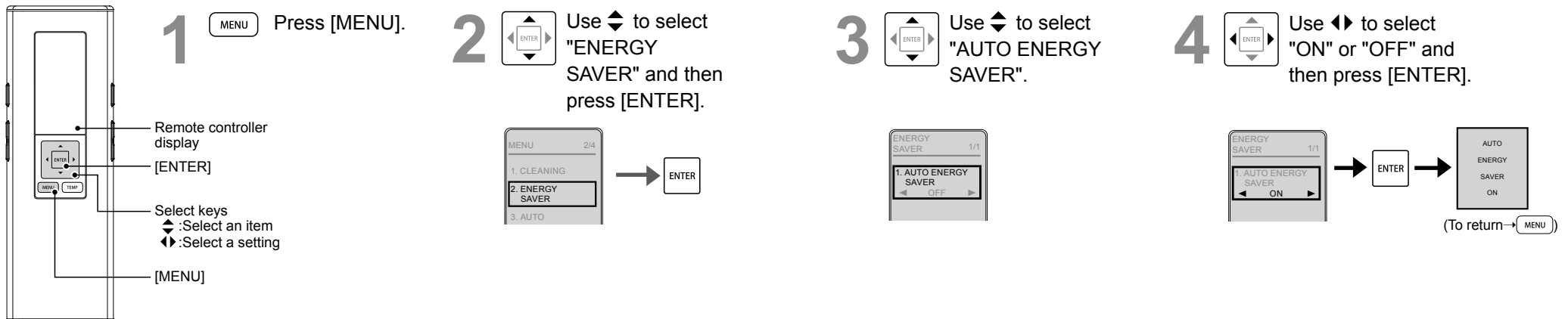

Maintenance

Power plug (Approximately once a month)

<Except electrical box type, Concealed power connection type>



Dry cloth



Wet cloth

- 1 Disconnect the power plug and wipe it with a dry cloth.



- 2 Insert the power plug.
 - The POWER LED lights up.

WARNING

- Periodically remove dust from the blades and other parts of the power plug.
 - Disconnect the plug and wipe it with a dry cloth.

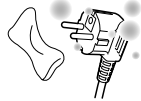

- Fully insert the power plug.
- When disconnecting, hold the main body of the power plug.
 - Pulling the cord may damage the plug or cord.

WARNING

- Always disconnect the power plug from the outlet before cleaning, maintenance or inspection. (see left)
 - Always switch the breaker on the distribution board to OFF. (Electrical box type, Concealed power connection type)
- (Failure to do so may cause electric shock or malfunction, resulting in a breakdown.)

For safety, disconnect the power plug before cleaning or maintenance.*

Switch the breaker on the distribution board to OFF.*

(Electrical box type, Concealed power connection type)

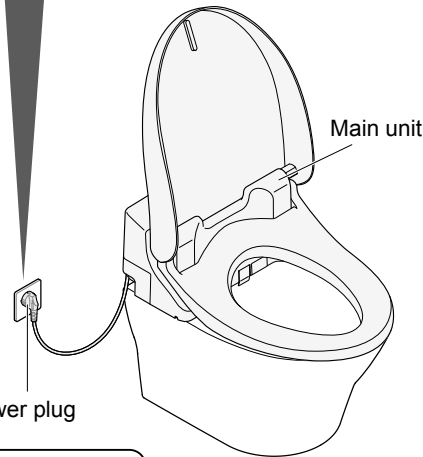

[Electrical box type]



Electrical box

Do not use a dry cloth or toilet paper on plastic parts.

(May cause damage.)

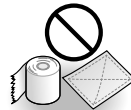

*Except when using "Wand cleaning".

Main Unit (Approximately daily)



Soft cloth soaked in water

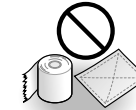

- Toilet paper
- Dry cloth
- Nylon scrubbing pads (May cause damage.)

- 1 Unplug the power plug. Switch the breaker on the distribution board to OFF. (Electrical box type, Concealed power connection type)
- 2 Wipe with a soft cloth that has been soaked in water and wrung-out thoroughly.

■ For heavy dirt

- Wipe with a soft cloth soaked in diluted, neutral kitchen detergent, and then wipe with a soft cloth soaked in water.



• Neutral kitchen detergent



- Paint thinner
- Benzene
- Powdered cleanser

- 3 Insert the power plug. Switch the breaker on the distribution board to ON. (Electrical box type, Concealed power connection type)

- The POWER LED lights up.

Attention!

- The Washlet is an electric appliance. Be careful not to let water seep inside or leave detergent in the gap between the main unit and toilet bowl. (May damage plastic parts or cause a malfunction.)
- When using a toilet cleaner to clean the toilet, wash it off within 3 minutes and leave the toilet seat and toilet lid open.
 - Wipe off any cleaner that remains on the toilet bowl. (If vapor from a toilet bowl cleaner enters the main unit, it may cause a malfunction.)
- Do not push or pull the covers around the wand with undue force. (May cause damage or malfunction.)
- Wipe the back surface of the toilet seat and the toilet seat cushions with a soft cloth tightly wrung out with water. (Otherwise adhesion of dirt may result in discoloration.)

Maintenance

Gap between the Main Unit and the Toilet Lid (Approximately once a month)

The toilet lid can be removed for thorough cleaning.

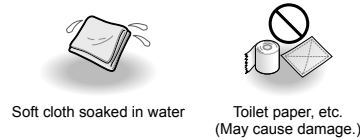

1 Unplug the power plug.

Switch the breaker on the distribution board to OFF.
(Electrical box type, Concealed power connection type)

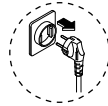

2 Remove the toilet lid.

- (A): Pull the left side outward.
↓
(B): Disconnect the hinge from the recess and pull up.
↓
(C): Disconnect the right side.

3 Wipe with a soft cloth that has been soaked in water and wrung-out thoroughly.

4 Reinstall the toilet lid.

- (D): Join the pin and the hinge on the right side.
↓
Slightly tilt the toilet lid to the front.
(A): While pulling out the left side,
↓
(E): Mount by joining the hinge with the recess.
* Be careful not to pinch your fingers.

5 Open and close the toilet lid to check the mounting, and then mount the main unit.

- ### 6 Insert the power plug.
- Switch the breaker on the distribution board to ON.
(Electrical box type, Concealed power connection type)
- The POWER LED lights up.

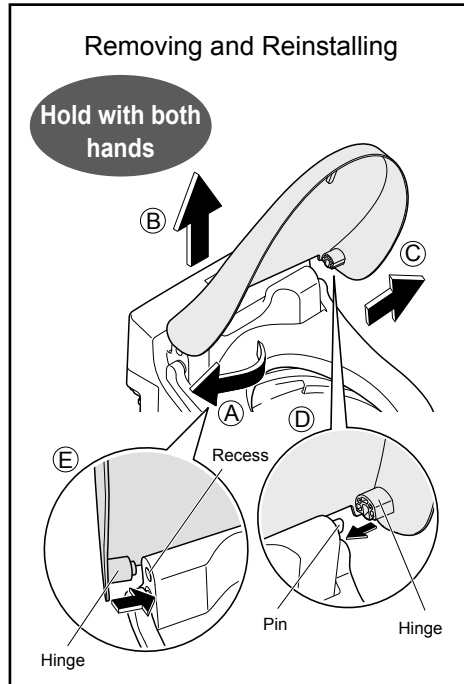

Deodorizing filter

(Approximately once a month)

- ### 1 Unplug the power plug.
- Switch the breaker on the distribution board to OFF.
(Electrical box type, Concealed power connection type)

- ### 2 Remove the deodorizing filter.
- Hold the knob and pull outward.
 - Do not pull with undue force.
(May cause damage or malfunctions)

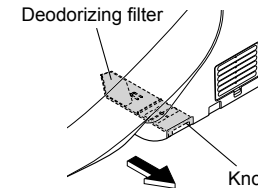

- ### 3 Clean with a tool such as a toothbrush.
- When washing with water, dry off all water before mounting.

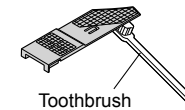

- ### 4 Mount the deodorizing filter.
- Push firmly until a click sound is heard.

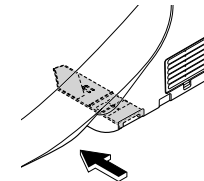

- ### 5 Insert the power plug.
- Switch the breaker on the distribution board to ON.
(Electrical box type, Concealed power connection type)
- The POWER LED lights up.

Wand (Approximately once a month)

Wand cleaning <If you notice dirt>

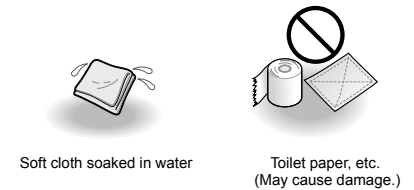

- ### 1 Extend the wand.
- Operate with the buttons on the back side of the remote control.

- (1) Press [MENU].
(2) Use \blacktriangle to select "CLEANING".
Press [ENTER].
(3) Use \blacktriangle to select "WAND CLEANING MODE ON/OFF".
Press [ENTER].
• The wand extends.

- ### 2 Wipe with a soft cloth that has been soaked in water.
- Do not pull, push or press the wand with excessive force.
(May cause damage or malfunction.)

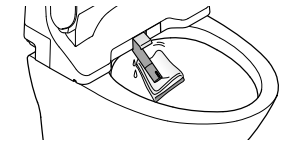

- ### 3 Press [STOP] on the front side of the remote control.
- The wand retracts.
 - Water comes out from around the wand.

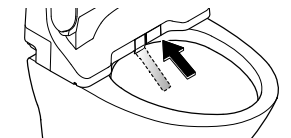

1. Spray Nozzle (Approximately once every 6 months)



General lime scale remover (liquid)



Other detergents

1 Remove the spray nozzle from the wand.

- (1) Extend the wand.
(Step 1 in "Wand" on page 29)

- (2) While holding the wand with a hand, press on both sides of the spray nozzle and slide it.
• Do not pull with undue force.
(May cause damage or malfunction.)

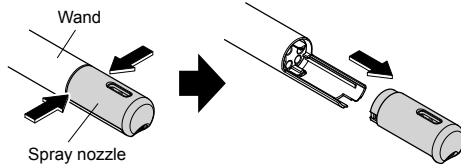

2 Install a spray nozzle (for replacement).

Check that the gasket (black) is attached.



- (1) Hold the wand by hand and slide the replacement spray nozzle along the guide and push it in.

- Install correctly until a click sound is heard.
- Do not push with undue force. (May cause damage or malfunction.)

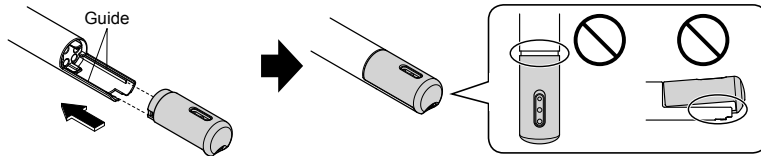

- (2) Press [STOP] on the front side of the remote control.

- The wand retracts.
- Water comes out from around the wand.

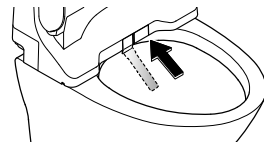

Cleaning the blocked Nozzle

Remove the spray nozzle and immerse it in general lime scale remover (liquid).

- Do not disassemble the spray nozzle. (May cause malfunctions.)

2. Water Filter Drain Valve, Water Drain Plug (Approximately once every 6 months)

<The water pressure is still weak even after cleaning the spray nozzle>



Neutral kitchen detergent

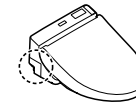

1 Close the shutoff valve. (P.41)

- The water supply stops.

CAUTION

- Do not remove the water filter drain valve while the shutoff valve is open. (Otherwise, water may leak out)

- ### 2 Extend the wand (Step 1 in "Wand" on page 29) and press [ENTER] again to retract the wand.

- (Release the pressure from the water supply pipe.)
• Water comes out from around the wand.

3 Unplug the power plug.

- Switch the breaker on the distribution board to OFF. (Electrical box type, Concealed power connection type)

4 Remove the cover and water filter drain valve.

- Loosen with a flat-head screwdriver and then pull.

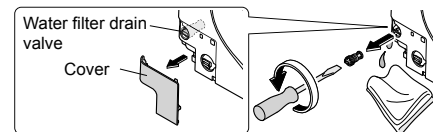

5 Loosen the water drain plug until its threads lose the grip.

- Water comes out from around the wand (it takes about 3 minutes to complete draining).

CAUTION

- Do not disconnect the water drain plug until draining is completed. (Otherwise, water may leak out)

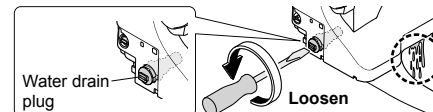

6 Remove the water drain plug.

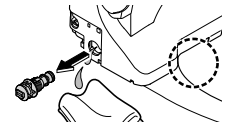

7 Clean the filter with a tool such as a toothbrush.

- Also, remove any dust from inside the hole.

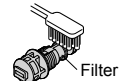
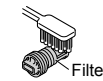

8 Push in the water drain plug and water filter drain valve, tighten them securely with a flat-head screwdriver and install the cover.



9 Insert the power plug.

- Switch the breaker on the distribution board to ON. (Electrical box type, Concealed power connection type)

- The POWER LED lights up.

10 Open the shutoff valve. (P.15)

11 Discharge water from the wand. (Step 3 in "Resupplying the Water" on page 39)

Changing Settings

Setting List

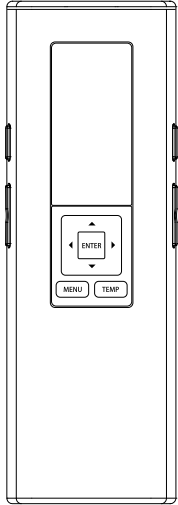



Setting Types			Available Settings Bold: Initial settings	Setting Ref. Page
AUTO FUNCTIONS	CLEANING	PRE-MIST	• Set whether or not to spray mist in the toilet bowl automatically ON/OFF	Page 34
		DEODORIZER	• Set whether or not to deodorize automatically ON/OFF	
OTHER SETTINGS	BEEP		• Set whether or not to make a beep sound ON/OFF	Page 36
	SETTING LOCK		• Set whether or not to use the setting lock ON/OFF	
	PERSONAL SETTING LOCK		• Set whether or not to use the personal setting lock ON/OFF	

Changing Settings

CLEANING

1  Press [MENU].

2  Use  to select "AUTO FUNCTIONS" and then press [ENTER].

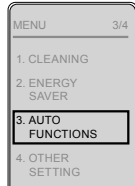



3  Use  to select "CLEANING" and then press [ENTER].



Set whether or not to spray mist in the toilet bowl automatically
PRE-MIST

4  Use  to select "PRE-MIST".





5  Use  to select "ON/OFF" and then press [ENTER].





(To return → )

Set whether or not to deodorize automatically
DEODORIZER

4  Use  to select "DEODORIZER".





5  Use  to select "ON/OFF" and then press [ENTER].

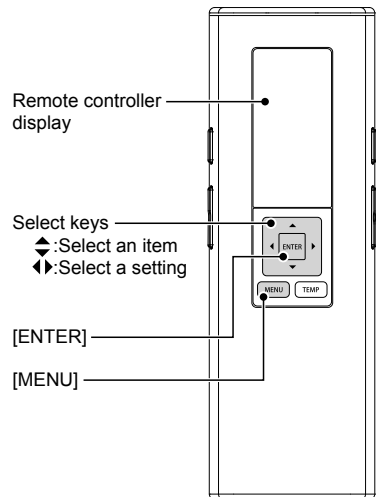

(To return → )



Select keys
: Select an item
: Select a setting

[ENTER]

[MENU]

Items set on this display

- 1. PRE-MIST
- 2. DEODORIZER

Changing Settings

OTHER SETTINGS

1 Press [MENU].

2 Use to select "OTHER SETTINGS" and then press [ENTER].

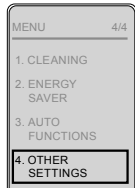

Set whether or not to make a beep sound
BEEP

3 Use to select "BEEP".



4 Use to select "ON/OFF" and then press [ENTER].

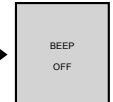

(To return →)

Set whether or not to use the setting lock
SETTING LOCK

3 Use to select "SETTING LOCK".

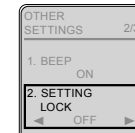

4 Use to select "ON/OFF" and then press [ENTER].

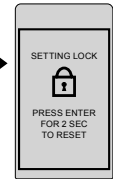
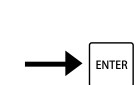
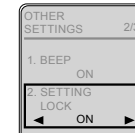

5 Check the displayed screen.



Cancellation method:
Press [ENTER] for 2 seconds or longer.

*If you want to relock after cancellation, reconfigure the setting.

Display screen during setting lock

Set whether or not to use the personal setting lock
PERSONAL SETTING LOCK

3 Use to select "PERSONAL SETTING LOCK".

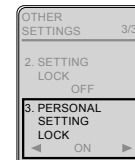

4 Use to select "ON/OFF" and then press [ENTER].

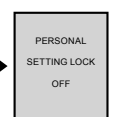
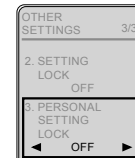

(To return →)

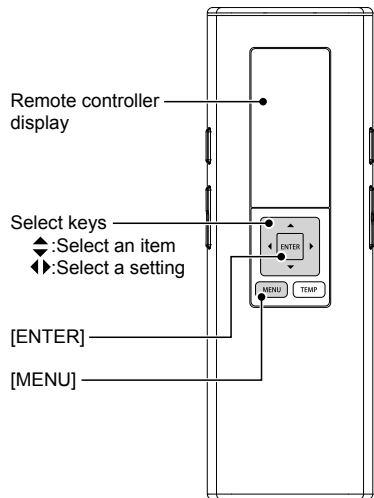

Select keys
: Select an item
: Select a setting

[ENTER]

[MENU]

Items set on this display

1. BEEP
2. SETTING LOCK
3. PERSONAL SETTING LOCK

What to Do?

If you cannot operate with the remote control

The batteries may have worn out.
Replace the batteries.

■ Replacing the batteries

- 1** Unplug the power plug.
Switch the breaker on the distribution board to OFF.
(Electrical box type, Concealed power connection type)
 - The POWER LED goes off.
- 2** Remove the remote control from the hanger.
(Page14)
- 3** Open the battery cover and replace the AA batteries.
(Page14)
- 4** Mount the remote control in the hanger.
- 5** Insert the power plug.
Switch the breaker on the distribution board to ON.
(Electrical box type, Concealed power connection type)
 - The POWER LED lights up.

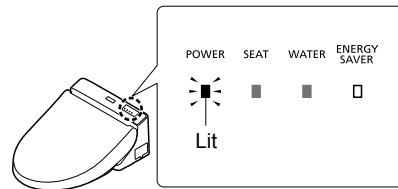

Freeze Damage Prevention

When the ambient temperature is likely to drop to 0°C or lower, take measures to prevent freezing.

Attention!

- When the ambient temperature is likely to drop to 0°C or lower, do not use the energy saver feature. (May damage the product.)
- Warm the bathroom or take measures against freezing so that the ambient temperature does not drop below 0°C.

Freeze damage prevention

■ How to drain the water

- 1** Close the shutoff valve.
 - The water supply stops.

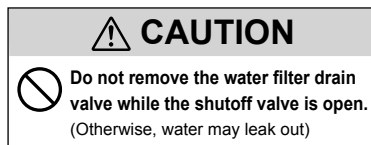

Freeze damage prevention (continued)

- 2** Drain the pipe.
 - (1) Extend the wand.
 - Operate with the buttons on the back side of the remote control.
 1. Press [MENU].
 2. Use \blacktriangle to select "CLEANING".
Press [ENTER].
 3. Use \blacktriangle to select "WAND CLEANING MODE ON/OFF".
Press [ENTER] to extend the wand and then press [ENTER] again to retract the wand. (Release the pressure from the water supply pipe.)
 - Water comes out from around the wand.
- (2) Unplug the power plug.
Switch the breaker on the distribution board to OFF. (Electrical box type, Concealed power connection type)
- (3) Remove the cover and water filter drain valve.

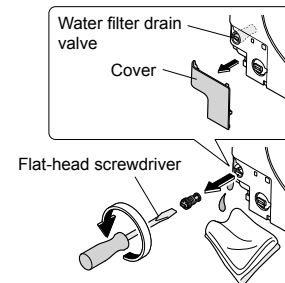

- (4) Drain the water from the water supply hose. (Expect Concealed power connection type)

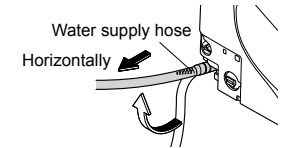

- (5) After draining the water, install the water filter drain valve and cover.
 - Insert the water filter drain valve and use a flat-head screwdriver to tighten it securely.

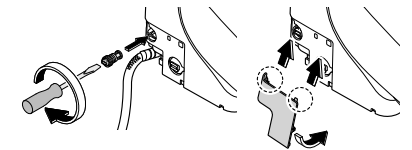

- (6) Insert the power plug.
Switch the breaker on the distribution board to ON. (Electrical box type, Concealed power connection type)

- 3** Check that the POWER LED on the main display is lit up. (Page 15)
- 4** Set the water and toilet seat temperature to "High". (Page 22)
(To maintain the temperature.)
 - When finished, close the toilet seat and toilet lid.

■ To use the Washlet again

- The water needs to be resupplied. (See below)

Resupplying the Water (After draining)

- 1** Open the shutoff valve.
 - Check that water is not leaking from a pipe or the main unit.
- 2** Insert the power plug.
Switch the breaker on the distribution board to ON.
(Electrical box type, Concealed power connection type)
- 3** Discharge water from the wand.
 - (1) Pressing down the right side of the toilet seat,
 - (2) Press [REAR] on the remote control to discharge water from the wand for about two minutes.
(It takes about one minute maximum before water comes out. Catch the water in a paper cup or other receptacle.)

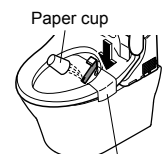

Soft cloth soaked in water (to prevent scratching)

■ If the remaining water has frozen and no water comes out

- Heat the inside of the bathroom, and warm the water supply hose and shutoff valve using a cloth soaked in warm water.

What to Do?

Long Periods of Disuse

If the toilet is in a location you will not visit for a long time, drain the water.
(The water in the tank may become contaminated and cause skin irritation or other problems.)

How to drain the water

- 1 Close the shutoff valve.
- 2 Drain the pipe.
(Step 2 (1) to (5) on Page 39)

*After draining water, keep the cover removed.

- 3 Loosen the water drain plug until its threads lose the grip.

- Water comes out from around the wand
(it takes about 3 minutes to complete draining).

CAUTION

- Do not disconnect the water drain plug until draining is completed.
(Otherwise, water may leak out)

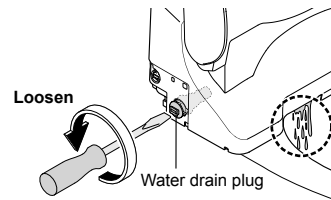

- 4 Tighten the water drain plug securely with a flat-head screwdriver and install the cover.

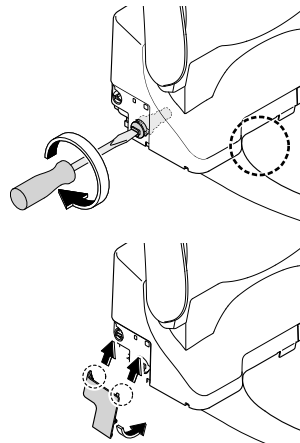

■ If water may get frozen

- Add antifreeze solution in the water in the bowl to prevent freezing.
(The antifreeze solution should not be flushed out. Collect it before using the toilet and dispose of it.)

■ To use the Washlet again

- The water needs to be resupplied. (Page 39)

Troubleshooting

First, try the actions described on pages 41 to 44.

If the problem persists, consult the installer, seller or the contact listed on the back cover of this manual.

⚠ CAUTION

! If a water leak occurs, close the shutoff valve.

[For shutoff valve (Concealed power connection type)]

Please check first

Is the **POWER LED** lit?

■ Is the breaker on the distribution board turned on?

→ Check whether there is a power outage or the breaker has turned "OFF".

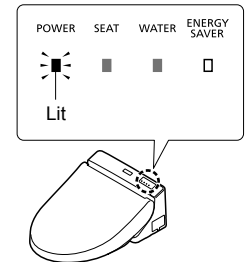

Is the **ENERGY SAVER LED** lit?

■ While the LED is lit, energy saver (Page 24) is in operation, so the toilet seat temperature may be reduced or the warm water heater and toilet seat heater may be turned off.

Is the remote control working?

■ Are the remote control batteries dead?

→ Replace the batteries. (Page 38)

■ Is the remote control transmitter or the remote control receiver blocked?

→ Remove obstructions, dirt, water droplets or any other blockages.

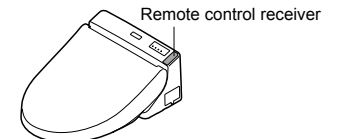
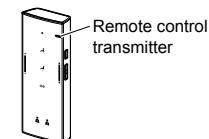
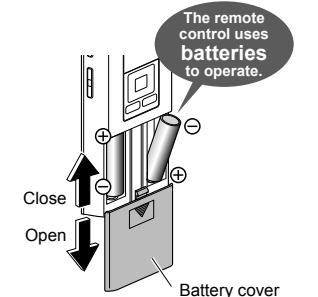

Troubleshooting

Rear and Rear soft, front cleansing, wand

Trouble	Please check	Ref. Page
The wand (or cleansing water) does not come out	<ul style="list-style-type: none"> When the temperature is low, it takes time for the wand to come out after the remote control button is pressed because the water must be warmed up first. 	-
	<ul style="list-style-type: none"> Did you sit on the toilet continuously for 2 hours or longer? (If so, operation is stopped for safety purposes.) →Stand up from the seat and then use again. 	-
	<ul style="list-style-type: none"> The seat switch will not turn on unless you sit on the seat properly. →Sit back on the toilet seat. 	11
	<ul style="list-style-type: none"> Are you using a toilet seat cover, a toilet lid cover or a seat for infants? →Remove any covers. When using a seat for infants or a soft highchair, remove after each use. 	11
The wand extends but the cleansing water does not come out / The cleansing water pressure is weak	<ul style="list-style-type: none"> Has a water failure occurred? →Press the "STOP" button and wait until water service is restored. 	-
	<ul style="list-style-type: none"> Is the shutoff valve closed? →Fully open the shutoff valve. 	15
	<ul style="list-style-type: none"> Is the wand or filter clogged with foreign matter? →Clean the spray nozzle, water filter drain valve and water drain plug. 	30 31
	<ul style="list-style-type: none"> Is the water pressure set to a low level? 	17
	<ul style="list-style-type: none"> Is the water drain plug loosened? →Tighten the water drain plug securely. 	40
The cleansing water is cold	<ul style="list-style-type: none"> Is the water temperature set to "OFF" or a low level? 	22
	<ul style="list-style-type: none"> When the temperature of the water supply or the bathroom is low, the water temperature may be low when first sprayed. 	-
	<ul style="list-style-type: none"> Is energy saver in operation? →Wait 10 minutes after having sat on the toilet seat. You can turn it "OFF" if the energy saver feature is "ON". 	24
Stops in the middle of use	<ul style="list-style-type: none"> Rear, rear soft and front cleansing stop automatically after 5 minutes of continuous use. Then the POWER LED (Green) and the ENERGY SAVER LED (Green) on the display of the main unit flash about 60 seconds while hot water is prepared. →Wait until the LEDs on the display of the main unit light up solidly and then press the button again. 	-
	<ul style="list-style-type: none"> Does the seat switch have difficulty detecting? →Sit back on the toilet seat. If you get up slightly from the seat, or sit forward on the seat, the seating switch may temporarily stop detecting your presence. 	11
Water comes out unexpectedly from the wand	<ul style="list-style-type: none"> Water comes out from the area around the wand for several seconds after you sit on and stand up from the toilet seat. 	-

Warm air drying

Trouble	Please check	Ref. Page
The dryer temperature is low	<ul style="list-style-type: none"> Is the dryer temperature set to low level? 	22
Stops in the middle of use	<ul style="list-style-type: none"> The feature stops automatically after 10 minutes of continuous use. Does the seat switch have difficulty detecting? →Sit back on the toilet seat. If you get up slightly from the seat, or sit forward on the seat, the seating switch may temporarily stop detecting your presence. 	- 11

Toilet Seat and Toilet Lid

Trouble	Please check	Ref. Page
The toilet seat is cold	<ul style="list-style-type: none"> Is the toilet seat temperature set to "OFF" or a low level? 	22
	<ul style="list-style-type: none"> Is the ENERGY SAVER LED (orange) lit? • When the SEAT LED (green) is also lit. →The toilet seat temperature has been lowered to save energy. When you sit, the toilet seat is temporarily heated. When the SEAT LED is OFF. →Energy saver is operating and has turned off the toilet seat heater. When you sit on the seat, the toilet seat heater is turned on temporarily and the seat is warmed in about 15 minutes. You can turn it "OFF" if the energy saver feature is "ON". 	24
	<ul style="list-style-type: none"> Have you been seated for a long time? • After about 20 minutes of sitting, the temperature starts going down, and after about 1 hour, the toilet seat heater is turned "OFF". →Stand up from the seat and then use again. 	-
	<ul style="list-style-type: none"> Did you put anything on the toilet seat or the toilet lid? →Remove the object from the toilet seat or the toilet lid. 	-
	<ul style="list-style-type: none"> The seat switch will not turn on unless you sit on the seat properly. →Sit back on the toilet seat. 	11
	<ul style="list-style-type: none"> Is a toilet lid or seat cover installed? →Remove any covers. 	11

Energy Saver

Trouble	Please check	Ref. Page
The energy saver feature is not working	<ul style="list-style-type: none"> Because the function takes several days learning the usage conditions before starting energy saver, the amount of energy saving may be low, depending on the frequency of use. →Check the energy saver feature. 	24

Troubleshooting

Deodorizer		
Trouble	Please check	Ref. Page
The deodorizer seems to be not working	<ul style="list-style-type: none"> ● Is "DEODORIZER" set to "OFF"? → Set to "ON". 	34
	<ul style="list-style-type: none"> ● Even after sitting down, you do not hear operation sounds. → Sit back on the toilet seat. 	11
	<ul style="list-style-type: none"> ● If you hear an operation sound when you sit on the toilet seat. → Clean the deodorizing filter. 	29
A strange odor is emitted	<ul style="list-style-type: none"> ● Are you using an air freshener or deodorizer that you purchased separately? • Doing so may reduce the effectiveness of the Washlet deodorizer or cause strange odors. → Remove the air freshener or deodorizer. 	-

Others		
Trouble	Please check	Ref. Page
Water is leaking from the plumbing connections	<ul style="list-style-type: none"> ● If any nuts in a connection are loose, firmly tighten them with a tool such as a monkey wrench. → If the water leak does not stop, close the shutoff valve and seek repair. 	-
The display on the remote control goes out	<ul style="list-style-type: none"> ● The display goes out when no button on the remote control is pressed for 5 minutes or more. 	14
The main unit is unstable	<ul style="list-style-type: none"> ● There is clearance between the toilet seat cushion and the toilet bowl for activating the seat switch. When you sit on the toilet seat, the toilet seat subsides slightly to activate the seat switch. 	11
The main unit makes a sound	When the toilet is occupied <ul style="list-style-type: none"> ● You hear an operation sound at intervals of a few seconds when the cleaning feature is working properly. 	-
	When sitting on the toilet seat <ul style="list-style-type: none"> ● You hear operation sounds for preparing the pre-mist or spraying mist in the toilet bowl. → You can turn it "OFF". 	20 34
	When moving away from the toilet bowl after use <ul style="list-style-type: none"> ● You may hear the sound of water being warmed up or the remaining water being drained. 	-
You feel air in the toilet bowl when sitting on the toilet seat	<ul style="list-style-type: none"> ● A mist is sprayed inside the toilet bowl to make it more difficult for dirt to adhere when sitting on the toilet seat. You may feel air when a mist is sprayed. → You can turn it "OFF". 	20 34

Specifications

Item		TCF6532	TCF6530		
Rated power supply		AC 220 - 240 V, 50 Hz			
Rated power consumption		249 - 294 W			
Maximum power consumption		276 - 321 W			
Type of water heater		Tank type			
Power cord length		About 1 m			
Water protection level		IPX4			
Functions	Cleansing	Spray volume	Rear cleansing	Approx. 0.29 - 0.60 L/min <at 0.20 MPa water pressure>	
			Rear soft cleansing	Approx. 0.29 - 0.55 L/min <at 0.20 MPa water pressure>	
			Front cleansing	Approx. 0.27 - 0.55 L/min <at 0.20 MPa water pressure>	
			Water temperature	Adjustable temperature range: OFF, about 30°C to 40°C	
			Toilet tank capacity	0.7 L	
			Heater capacity	195 - 232 W	
		Safety device	Temperature fuse, overheat shutoff switch (bimetal automatic return type), anti-idling float switch		
		Backflow prevention device	Vacuum breaker, Air gap according to EN1717		
	Warm air dryer	Warm air temperature*	Adjustable temperature range : about 37°C to 55°C		
		Airflow volume	Approx. 0.27 m ³ /min		
		Heater capacity	185 - 220 W		
	Heated seat	Safety device	Temperature fuse		
			Adjustable temperature range: OFF, about 28°C to 36°C <About 26°C when energy saver is in operation>		
Heater capacity		45 - 54 W			
Method		O ₂ deodorization			
Deodorizer	Airflow volume	Approx. 0.16 m ³ /min			
	Power consumption	Approx. 5.3 W			
Water supply pressure		Minimum required water pressure: 0.1 MPa <dynamic>, Maximum required water pressure: 1.0 MPa <static>			
Water supply temperature		0°C to 35°C			
Working ambient temperature		0°C to 40°C			
Dimensions		W 391 mm × D 523 mm × H 188 mm	W 391 mm × D 480 mm × H 188 mm		
Weight		Approx. 5.6 kg	Approx. 5.4 kg		

* Temperature around the warm air outlet measured by TOTO.

Warranty

LIMITED TWO YEARS WARRANTY

1. TOTO warrants its products to be free from manufacturing defects under normal use and service for a period of two (2) years from the date of purchase. This warranty is extended only to the ORIGINAL PURCHASER.
2. TOTO's obligations under this warranty are limited to repair or replacement, at TOTO's option, of products or parts found to be defective, provided that such products were properly installed and used in accordance with this OWNER'S MANUAL. TOTO reserves the right to make such inspections as may be necessary to determine the cause of the defect. TOTO will not charge for labour or parts in connection with warranty repairs or replacements.
TOTO is not responsible for the cost of removal, return and/or reinstallation of products.
3. This warranty does not apply to the following items:
 - a) Damage or loss sustained in a natural calamity such as fire, earthquake, flood, thunder, electrical storm, etc.
 - b) Damage or loss resulting from any unreasonable use, misuse, abuse, negligence, or improper maintenance of the product.
 - c) Damage or loss resulting from removal, improper repair, or modification of the product.
 - d) Damage or loss resulting from sediments or foreign matter contained in a water system.
 - e) Damage or loss resulting from the quality of water in the region where the product is used.
 - f) Damage or loss resulting from improper installation or from installation of a unit in a harsh and/or hazardous environment.
4. This warranty gives you specific legal rights. You may have other rights which vary from country to country.
5. To obtain warranty repair service under this warranty, you must take the product or deliver it prepaid to a TOTO service facility, together with a letter stating the problem, or contact a TOTO distributor or product service contractor, or directly to a TOTO sales office. If, because of the size of the product or nature of the defect, the product cannot be returned to TOTO, receipt by TOTO of a written notice of the defect shall constitute delivery. In such case, TOTO may choose to repair the product at the purchaser's location or pay to transport the product to a service facility.

This written warranty is the only warranty made by TOTO. Repair or replacement as provided under this warranty shall be the exclusive remedy available to the purchaser. TOTO shall not be responsible for loss of use of the product or for other incidental, special, or consequential damage or expenses incurred by the purchaser, or for labour or other costs due to installation or removal, or costs of repairs by others, or for any other expense not specifically stated above. Except to the extent prohibited by applicable law, any implied warranties, including that of merchantability or fitness for use, are expressly limited to the duration of this warranty. Some nations do not allow limitations on how long an implied warranty lasts, or the exclusion or limitation of incidental or consequential damage, so the above limitation and exclusion may not apply to you.

Important User Guidance Information



If you want to dispose this product, do not mix it with general household waste. There is a separate collection system for used electronic products in accordance with legislation that requires proper treatment, recovery and recycling.

Private households in the member states of the EU, Switzerland and Norway may return their used electronic products free of charge to designated collection facilities or to a retailer (if you purchase a similar new one).

For countries not mentioned above, please contact your local authorities for the correct method of disposal. By doing so you will ensure that your disposed product undergoes the necessary treatment, recovery and recycling, which prevent potential negative effects on the environment and human health.

Only discard discharged batteries. They should not be disposed of with household waste, but rather at appropriate collection sites or at the product retailer.